

CA

Manual-Feed Soldering Station

Ref.: **CA-9QG** 100V

CA-1QG 120V

CA-2QG 230V

CONTROL UNIT



CC1001

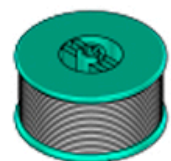

SN5450

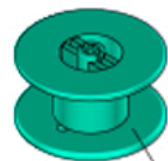

0002801

| SPARE PARTS | |
|----------------------|---------|
| CONTROL UNIT: | |
| -CIRCUIT | 0025013 |
| -ENCLOSURE | 0023639 |
| -TOOL HOLDER | 0014706 |
| -SPLASHGUARD | 0028379 |
| -ANTISPLASH MEMBRANE | CL7882 |

Ref.: CA-9QG 100V FUSE T-2A
Ref.: CA-1QG 120V FUSE T-2A
Ref.: CA-2QG 230V FUSE T-1A
EARTHING FUSE F 1.25A

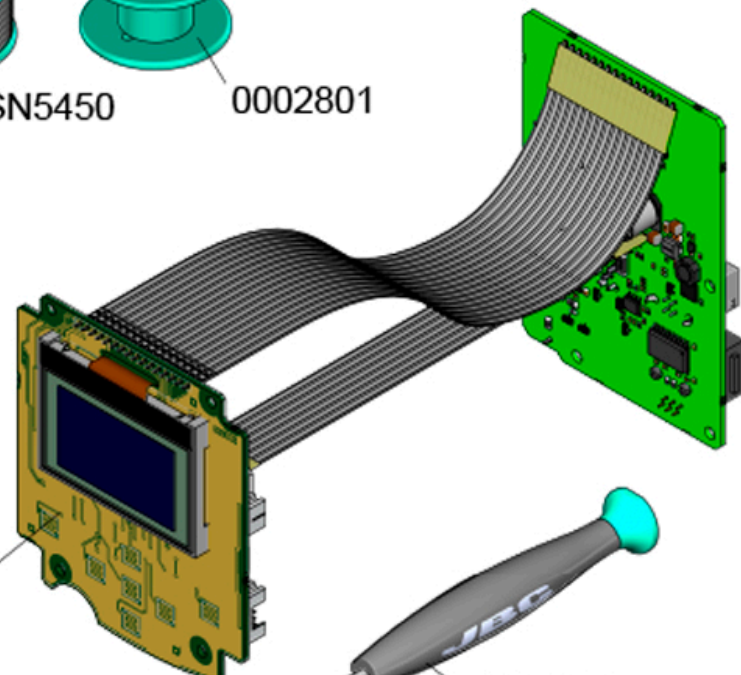

0010433

0025013

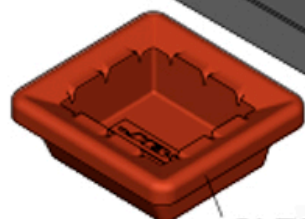

CL7984

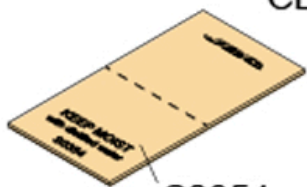

S0354



CL6210



0016351

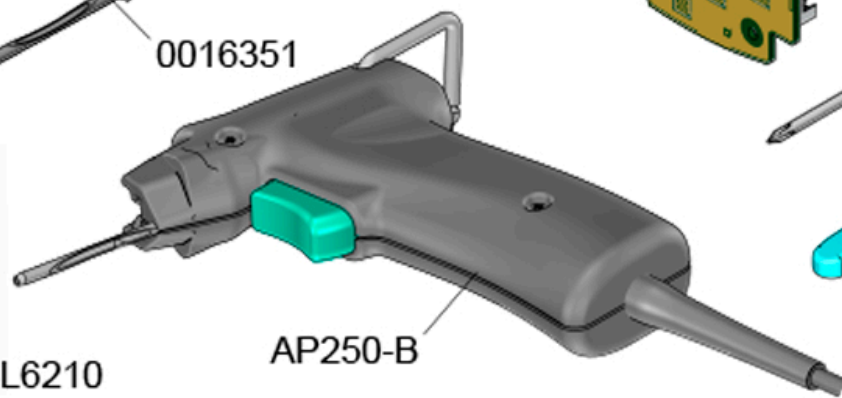

AP250-B

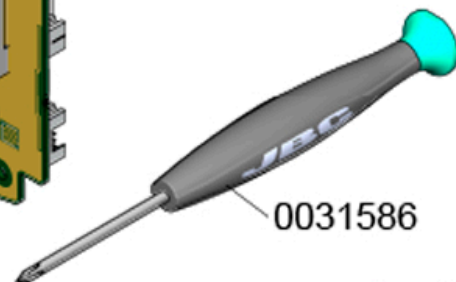

0031586



PLR195