

ALE

Automatic-Feed Soldering Station With Solder Wire Perforation

Ref.:

for wire Ø 0.80 - 0.82 mm

- ALE-908VB (100 V)
- ALE-108VB (120 V)
- ALE-208VB (230 V)

for wire Ø 1.50 - 1.57 mm

- ALE-915VB (100 V)
- ALE-115VB (120 V)
- ALE-215VB (230 V)

for wire Ø 0.90 - 1.10 mm

- ALE-910VB (100V)
- ALE-110VB (120V)
- ALE-210VB (230V)

for wire Ø 1.60 - 1.63 mm

- ALE-916VB (100 V)
- ALE-116VB (120 V)
- ALE-216VB (230 V)

for wire Ø 1.14 - 1.27 mm

- ALE-912VB (100 V)
- ALE-112VB (120 V)
- ALE-212VB (230 V)



Guide Wheels and Components already assembled in ALE Control Unit

- for wire Ø 0.80 - 0.82 mm - Ref. GALE08V-B
- for wire Ø 0.90 - 1.10 mm - Ref. GALE10V-B
- for wire Ø 1.14 - 1.27 mm - Ref. GALE12V-B
- for wire Ø 1.50 - 1.57 mm - Ref. GALE15V-B
- for wire Ø 1.60 - 1.67 mm - Ref. GALE16V-B

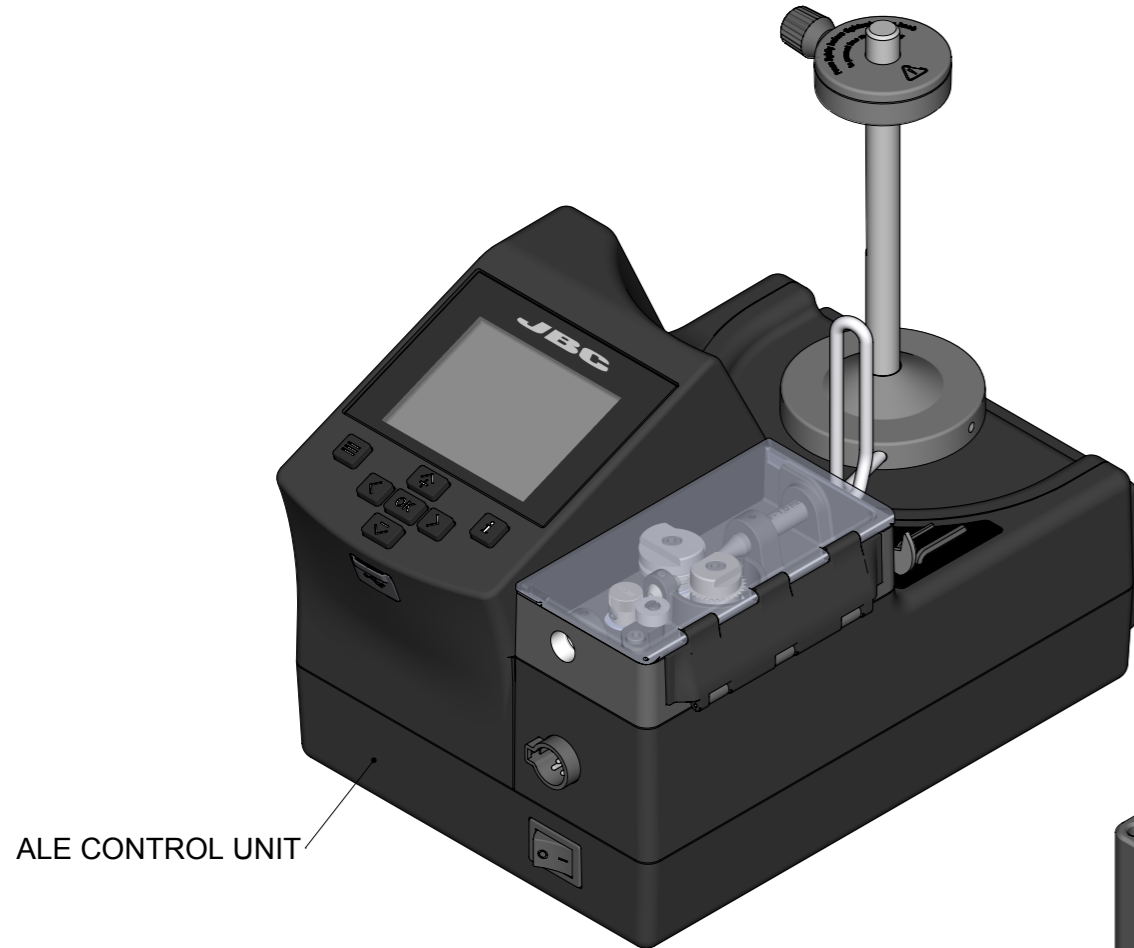

ALE CONTROL UNIT

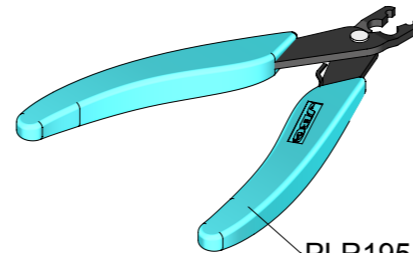

PLR195

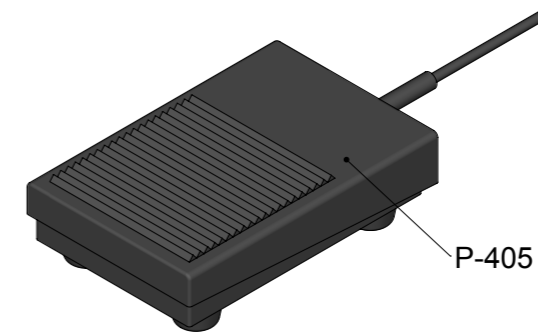

P-405

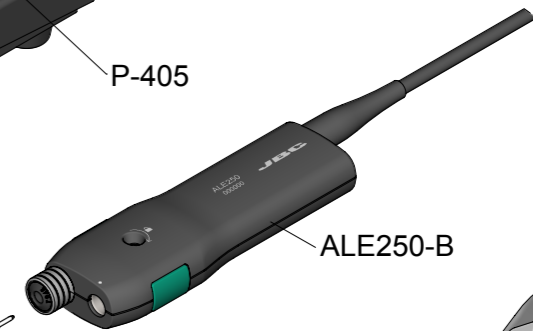

ALE250-B

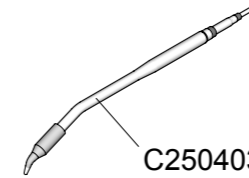

C250403

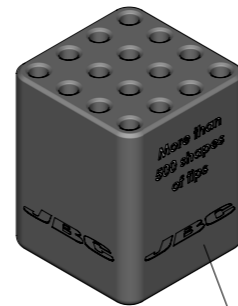

SCH-A



CL6210

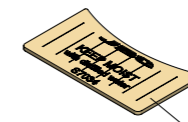

S7034

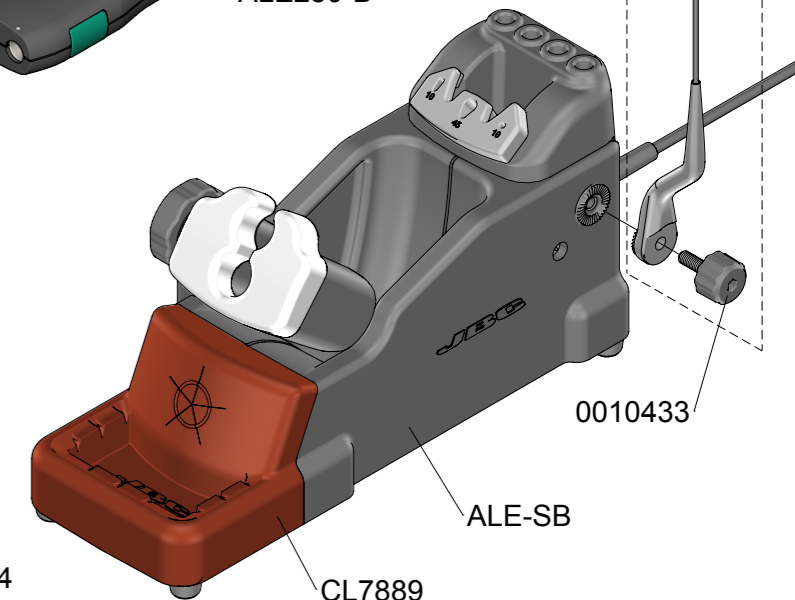

ALE-SB

CL7889

0010433

0024028

CC1001