

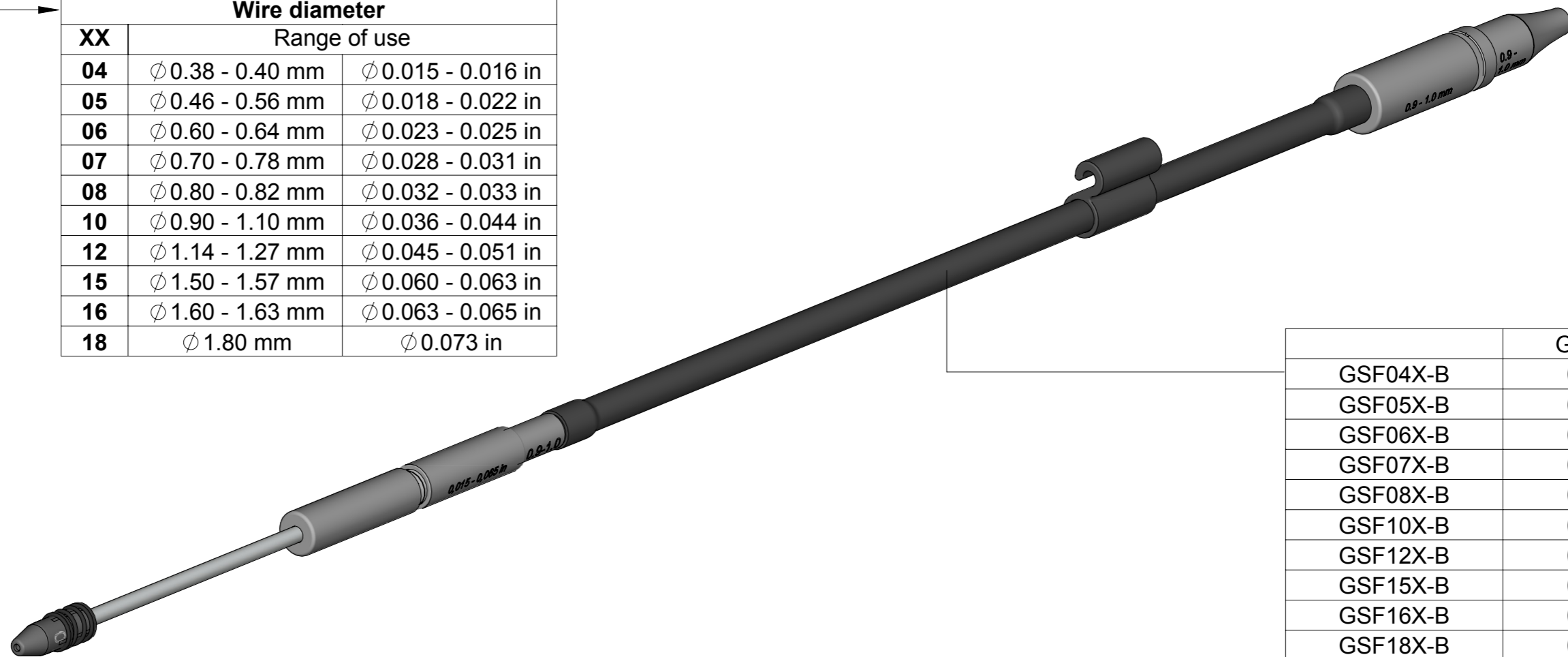





GSFXXD-B WITHOUT SOLDER WIRE PERFORATION

XX	Wire diameter	
	Range of use	
04	∅ 0.38 - 0.40 mm	∅ 0.015 - 0.016 in
05	∅ 0.46 - 0.56 mm	∅ 0.018 - 0.022 in
06	∅ 0.60 - 0.64 mm	∅ 0.023 - 0.025 in
07	∅ 0.70 - 0.78 mm	∅ 0.028 - 0.031 in
08	∅ 0.80 - 0.82 mm	∅ 0.032 - 0.033 in
10	∅ 0.90 - 1.10 mm	∅ 0.036 - 0.044 in
12	∅ 1.14 - 1.27 mm	∅ 0.045 - 0.051 in
15	∅ 1.50 - 1.57 mm	∅ 0.060 - 0.063 in
16	∅ 1.60 - 1.63 mm	∅ 0.063 - 0.065 in
18	∅ 1.80 mm	∅ 0.073 in

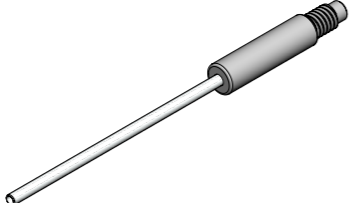
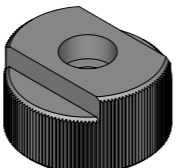
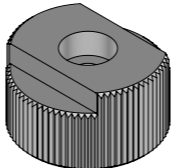
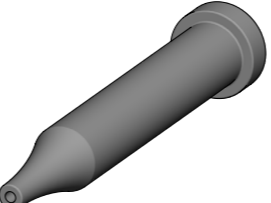

	Guide tube
GSF04X-B	0033048
GSF05X-B	0019521
GSF06X-B	0033049
GSF07X-B	0033050
GSF08X-B	0018630
GSF10X-B	0019168
GSF12X-B	0026113
GSF15X-B	0019169
GSF16X-B	0026115
GSF18X-B	0033051

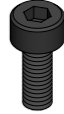
SPARE PARTS

	Outlet nozzle	Nozzle	Traction wheel	Support wheel	Inlet nozzle	Interm. nozzle	Counter wheel	Screws	Threaded stud
Wire ∅									
GSF04D-B	0032512	0030913	0019479	0020345	0019520	0024954	0026693	0026695 (x2)	0026696 (x3)
GSF05D-B	0025268			0019519		0018632			
GSF06D-B	0022994			0019480	0025291				
GSF07D-B	0025289				0019170				
GSF08D-B	0025270			0019481		0024956			
GSF10D-B	0021560				0019171	0024957			
GSF12D-B	0025272			0024233		0024958			
GSF15D-B	0025274				0024234	0024959			
GSF16D-B	0025276			0024960		0026694			
GSF18D-B	0021559								