

JBC

www.jbctools.com

INSTRUCTION MANUAL



DR560













Desoldering Iron

This manual corresponds to the following references:

DR560-A
5650020 - *Desoldering Iron only*

Packing List

The following items are included according purchased order reference:

 <p>Desoldering Iron 1 unit Tip Ref. C560003 <i>Through-Hole Desold. Ø 1 already inserted</i></p>	 <p>Spanner 1 unit Ref. 0780550</p>	 <p>Tip Cleaning Rods 1 unit Ref. CL5970</p>	 <p>Helical Tip Cleaning Rods 1 unit Ref. CL5760</p>
 <p>Cleaning stick 1 unit Ref. 0786640*</p>	 <p>Spiral Filter 1 unit Ref. 0812330</p>	 <p>Metal Solder Collector 1 unit Ref. 0812630</p>	 <p>Glass Solder Collector 1 unit Ref. 0812620</p>
 <p>Union Flanges 1 box Ref. 0033093* <i>Ref. includes 4 flanges, already assembled</i></p>	 <p>Manual 1 unit Ref. 0028057</p>	 <p>Internal Gasket 2 units Ref. 0019208</p>	 <p>Metal Brush ... 1 unit Ref. CL6217</p>
 <p>Filter box 1 unit Ref. 0780840* <i>Ref. contains 10 filters</i></p>	<p>Accessory Set for DR560 Ref. 0022820*</p>		

* not supplied in Ref. 5650020

Features and Connections

Desoldering Iron Ref. DR560-A

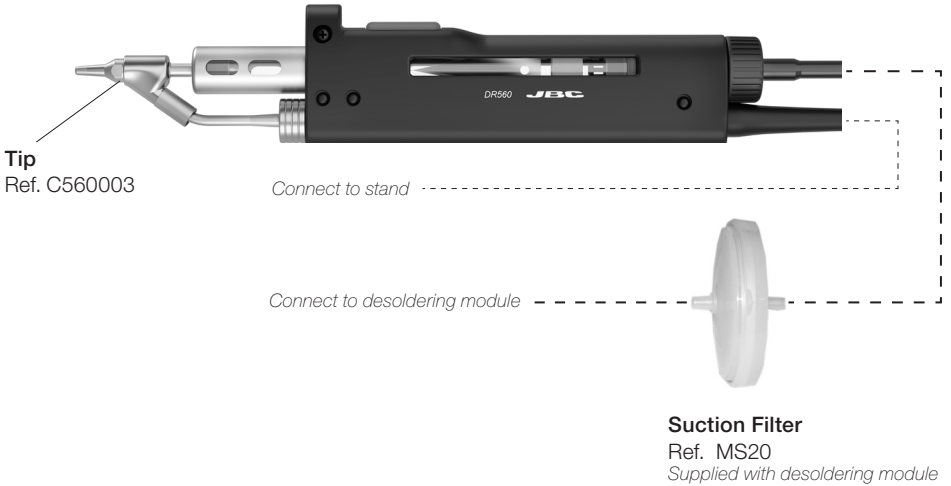

Desoldering Process

Use a tip with a larger diameter than the pad to achieve maximum aspiration and thermal efficiency.

1. Placing

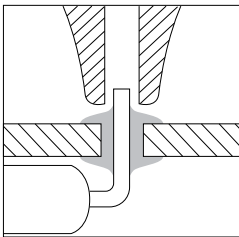

Place the tip with the component terminal in the hole.

2. Circular movement

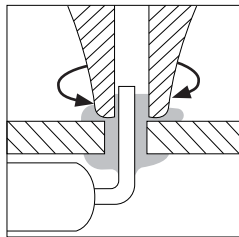

When the solder joint liquifies gently describe circles around the pin. Using the pin as the center of your movement.

3. Aspirating

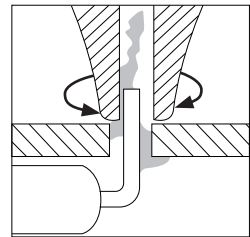

Press the vacuum pump button long enough to remove the solder.

After pressing the desoldering key there is a slight delay until the self-contained vacuum pump stops. This makes sure that the vacuum circuit is completely empty. If any solder remains are left on a terminal after desoldering it, resolder it with fresh solder and repeat the desoldering operation.

Changing Tips

This operation should be done while the tip is hot and at a minimum temperature of 250°C, so that any tin left inside is still molten.

1. Removing

Use the special spanner to unscrew the tip.

2. Inserting

Fit the new tip and tighten with the spanner to make sure it is air tight.

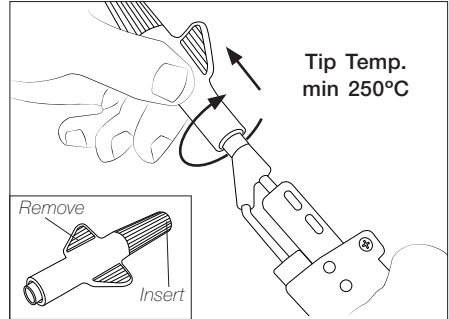

Compatible Tips

DR560 uses C560 tips. Different sizes are available for through-hole desoldering and for pad cleaning. Find the model that best suits your soldering needs at: www.jbctools.com

Through-Hole
Desoldering



Pad Cleaning



Changing the Heating Element (Ref. DSV-DR)

For this operation, turn off the station or disconnect the tool and wait until the tool temperature drops to room temperature.

1. Removing

Loosen the deposit lid (a), remove the screw (b) and withdraw the heating element (c).

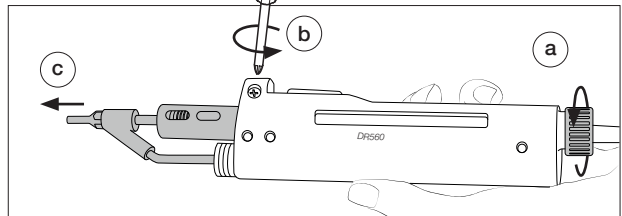

2. Placing

Insert the new heating element (a), tighten the screw (b) and then the deposit lid (c).

⚠ Before inserting, make sure the internal gasket is inserted into the glass solder collector.

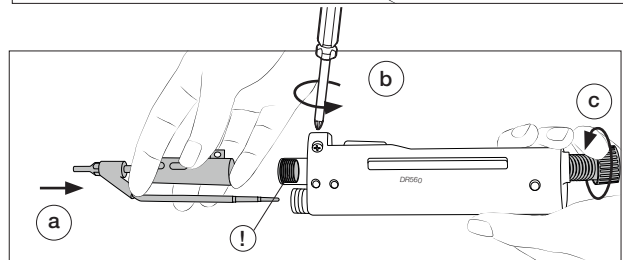

3. Connection

⚠ For a proper connection it is essential to insert the cartridge by lining it up to the mark ▶.

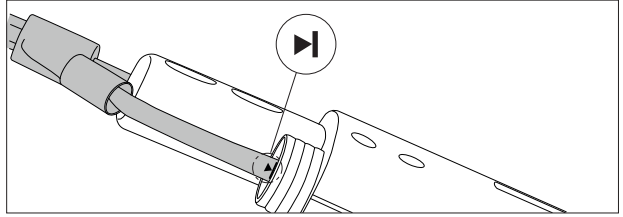

Compatibility

The DSV-DR also works with the previous version DR560 Desoldering Iron (Ref. 5600010). In this case, you must take out the washer with a pliers.

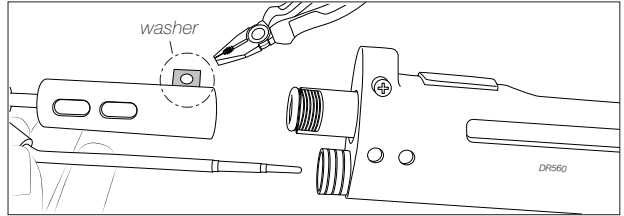

Glass Solder Collector Cleaning

1. Removing the Lid

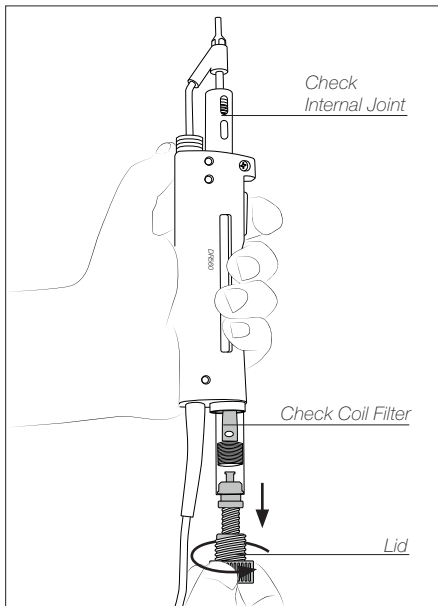

The lid must be unscrewed with the DR560 in a vertical position.

2. Cleaning

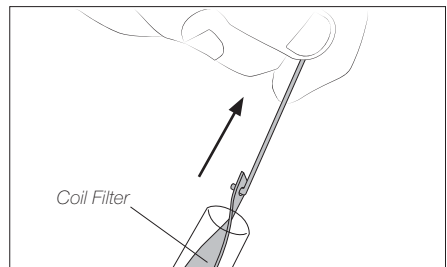

Remove the coil filter, check the filter and replace it if it is dirty or damaged.

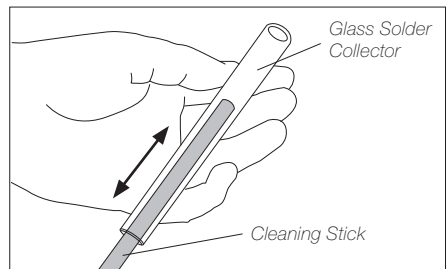

Clean the inside of the glass solder collector with the cleaning stick.

3. Inserting the Glass Solder Collector

The glass solder collector must be inserted with the coil filter in place, positioned between the 2 lines marked.

Then the whole unit must be closed by on screwing the lid.

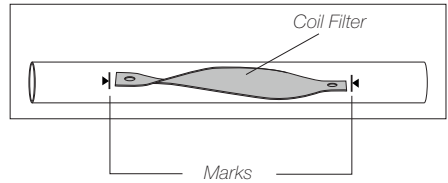

Tip Care

The intake tube should be periodically cleaned by the largest possible rod.

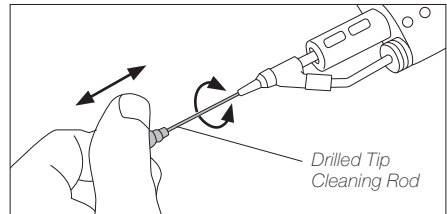
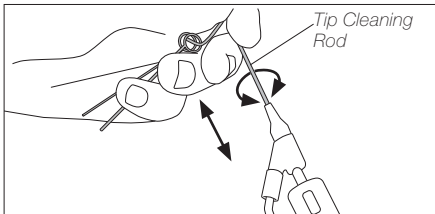

Do not press the vacuum pump button while tinning the desoldering tip, as the fumes given off by the flux would quickly block the ducts and the air filter.

Maintenance

Before carrying out maintenance or storage, always unplug the tool.

- Check periodically that the metal parts are clean to ensure it is detected when on the stand. Always use a damp cloth or alcohol.
- Periodically check all cables and tubes connections.
- Replace any defective or damaged pieces. Use original JBC spare parts only.
- Repairs should only be performed by a JBC authorized technical service.

Safety



It is imperative to follow safety guidelines to protect health and prevent electric shock, injury, fire or explosions.

- Do not use the tool for any purpose other than soldering or rework. Incorrect use may cause fire.
- The mains cable must be plugged into approved bases. Make sure that it is properly grounded before use. When unplugging it, hold the plug, not the wire.
- The temperature of accessible surfaces may remain high after the unit is turned off. Handle with care.
- Do not leave the appliance unattended when it is on.
- It is necessary to turn the station off before changing tips.
- Heat can cause inflammable products to ignite even when out of sight.
- Be careful with the remains of liquid tin. In contact with skin, it can cause burns.
- Avoid flux coming into contact with skin or eyes to prevent irritation.
- Be careful with the fumes produced when soldering.
- Keep your workplace clean and tidy. Wear appropriate protection glasses and gloves when working to avoid personal harm.
- This appliance can be used by children over the age of eight as well as persons with reduced physical, sensory or mental capabilities or lacking of experience provided that they have been given adequate supervision or instruction concerning use of the appliance and understand the hazards involved. Children must not play with the appliance.
- Maintenance must not be carried out by children unless supervised.

Specifications

DR560

Desoldering Iron *(with accessories)*

Ref.: **DR560-A**

- Total Net Weight: 413 g / 0.91 lb
- Package Dimensions / Weight: 306 x 131 x 71 mm / 559 g
- (L x W x H) 12.05 x 5.16 x 2.80 in / 1.23 lb

5650020

Desoldering Iron *(without accessories)*

Ref.: **5650020**

- Total Net Weight: 268 g / 0.59 lb
- Package Dimensions / Weight: 306 x 131 x 71 mm / 393g
- (L x W x H) 12.05 x 5.16 x 2.80 in / 0.87 lb

Complies with CE standards

ESD safe

JBC

Warranty

JBC's 2 year warranty covers this equipment against all manufacturing defects, including the replacement of defective parts and labor.

Warranty does not cover product wear or misuse.

In order for the warranty to be valid, equipment must be returned, postage paid, to the dealer where it was purchased.



This product should not be thrown in the garbage.

In accordance with the European directive 2012/19/EU, electronic equipment at the end of its life must be collected and returned to an authorized recycling facility.



www.jbctools.com

0028057-300724